

# Slim Line Sliding Patio Doors

Slim Line Patio Doors by Thermo-Tech are engineered for superior performance, durability and energy efficiency. High-performance insulated glass provides comfort and energy savings. Dual ball bearing adjustable rollers make operation a breeze. The sleek lines and slim stiles and rails offer a contemporary look with a maximum viewing area.

## STANDARD FEATURES

- Available in standard or custom sizes
- 3-color choices
- High-performance LoE<sup>3</sup>™ 366 or standard LoE<sup>2</sup>™ 272 insulated glass
- Decorative inner grids available
- Hardware matches interior and exterior colors
- Dual point locking mechanism for security
- Fusion-welded frame and sashes
- Optional keyed lock system
- Multi-chambered for insulation and strength
- Dual weather-stripping
- Heavy duty plated steel tandem rollers on a raised stainless steel monorail track system for smooth and easy operation
- Aluminum threshold and aluminum screen track protects the sill from debris and damage
- Sliding adjustable aluminum screws with BetterVue® fiberglass mesh



## QUALITY CONSTRUCTION FOR DURABILITY AND SUPERIOR ENERGY SAVINGS:

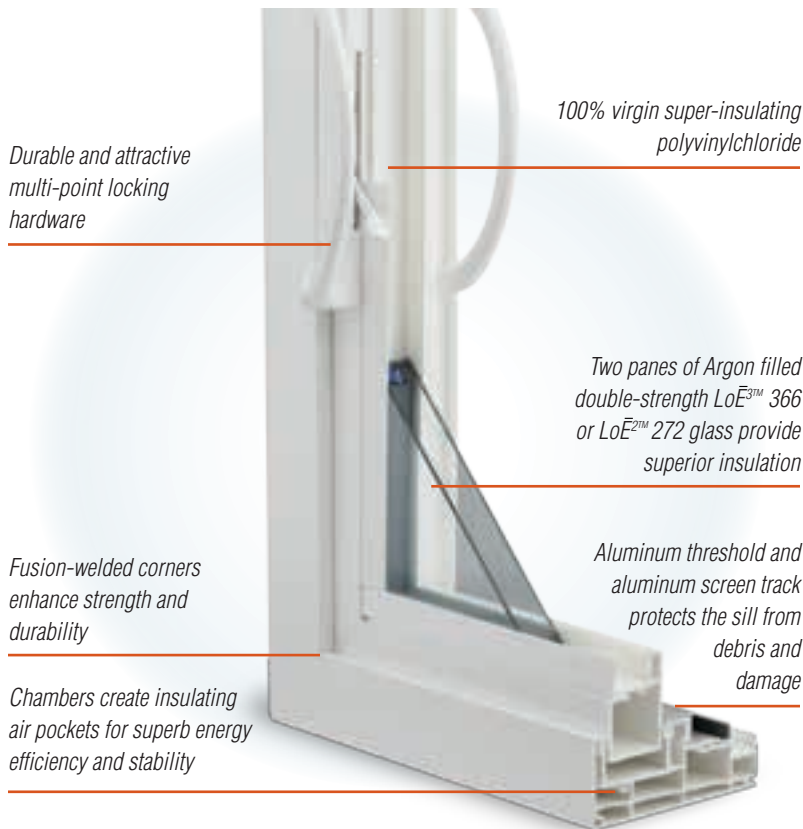

## DOOR COLORS

Available in popular standard colors to fit any home decor.

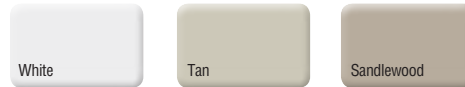

White, Tan and Sandlewood.

## C-HANDLE COLOR OPTIONS

Heavy-duty standard hardware is available in white, tan or sandlewood to match your patio door color.

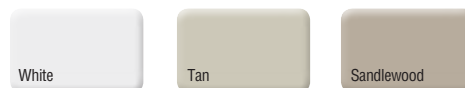

White, Tan and Sandlewood.



## GRIDS

The 5/8" flat or 3/4" contoured aluminum inner grids are matched to the door color and installed in the insulated air space between the panes of glass.

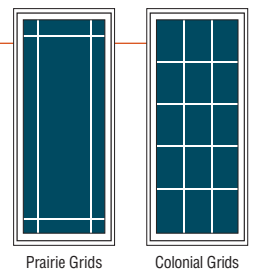

## CONFIGURATIONS

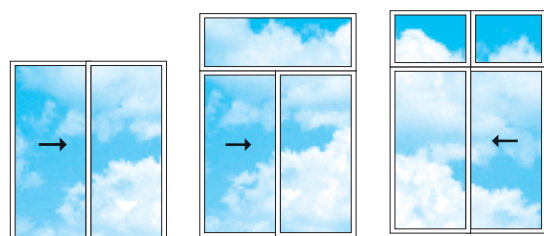

SLIM LINE PATIO DOORS – STANDARD SIZES

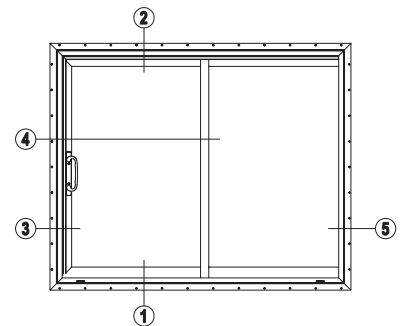
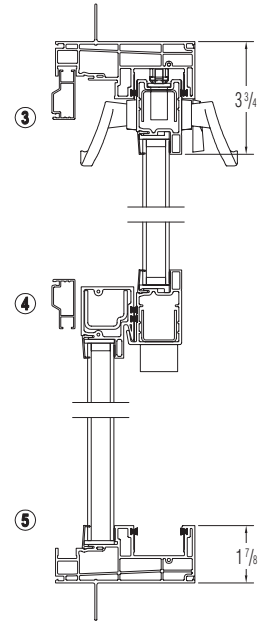
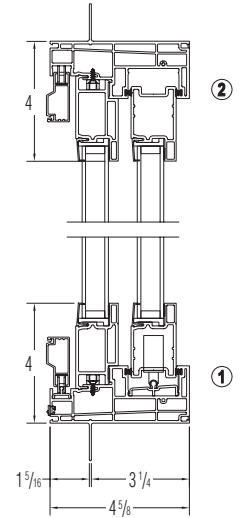
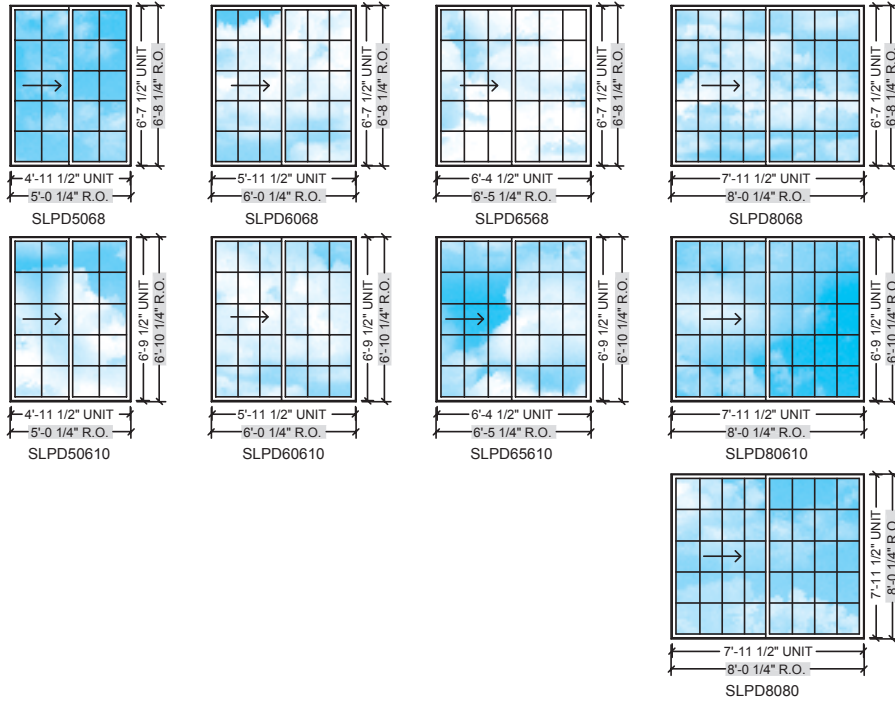

SLIM LINE PATIO DOORS TRANSOMS – STANDARD SIZES

UNIT DIMENSIONS		4'-11 1/2"	5'-11 1/2"	6'-4 1/2"	7'-11 1/2"
ROUGH OPENINGS		5'-0 1/4"	6'-0 1/4"	6'-5 1/4"	8'-0 1/4"
1'-0"	1'-0 3/4"				
1'-5 1/2"	1'-6 1/4"				
1'-11 1/2"	2'-0 1/4"				
1'-0"	1'-0 3/4"				
1'-5 1/2"	1'-6 1/4"				
1'-11 1/2"	2'-0 1/4"				
1'-0"	1'-0 3/4"				
1'-5 1/2"	1'-6 1/4"				
1'-11 1/2"	2'-0 1/4"				
1'-0"	1'-0 3/4"				
1'-5 1/2"	1'-6 1/4"				
1'-11 1/2"	2'-0 1/4"				

